



# CARFAX History-Based Value

## 2012 JEEP WRANGLER SPORT

VIN: 1C4AJWAGXCL126496

Body: 2 DOOR SUV SPORT UTILITY

Engine: 3.6L V6 285HP 260FT LBS

Drivetrain: 4X4

Fuel: GASOLINE



### History events affecting this vehicle's value



# \$18,640

## CARFAX History-Based Retail Value

### Assumptions

- Trim: SPORT
- Current: Excellent condition
- Condition:
- Zip Code: 20158
- Mileage: 61,264 miles
- Color: Orange exterior

Please contact the dealer to update the assumptions for this vehicle.

This CARFAX History-Based Value is based only on information supplied to CARFAX and available as of 10/19/2019 at 7:38PM EST. Other information that may affect the value of the vehicle may not have been reported to CARFAX. To learn more, please click here .

© 2019 CARFAX, Inc., a unit of IHS Inc. All rights reserved.  
Covered by United States Patent Nos. 7,113,853; 7,778,841; 7,596,512, 8,600,823; 8,595,079; 8,606,648; 7,505,838.



# Vehicle History Report™

US \$39.99

## 2012 JEEP WRANGLER SPORT

VIN: 1C4AJWAGXCL126496  
 UTILITY (BLAZER, JIMMY, SCOUT, ETC.)  
 3.6L V6 F DOHC 24V  
 GASOLINE  
 REAR WHEEL DRIVE W/ 4X4

### This CARFAX Report Provided by:

Auto Link  
 101 E Colonial Hwy  
 Hamilton, VA 20158  
 (540) 338-5465  
 www.autolinkonline.net



Accident reported



3 Previous owners



At least 1 open recall



24 Service history records



Personal vehicle



61,124 Last reported odometer reading



This CARFAX Vehicle History Report is based only on information supplied to CARFAX and available as of 10/4/19 at 3:27:27 PM (CDT). Other information about this vehicle, including problems, may not have been reported to CARFAX. Use this report as one important tool, along with a vehicle inspection and test drive, to make a better decision about your next used car.

Ownership History <small>The number of owners is estimated</small>	Owner 1	Owner 2	Owner 3
Year purchased	2011	2015	2017
Type of owner	Personal	Personal	Personal
Estimated length of ownership	3 yrs. 11 mo.	11 months	2 yrs. 4 mo.
Owned in the following states/provinces	New York	New York	New York
Estimated miles driven per year	7,532/yr	—	9,025/yr
Last reported odometer reading	29,966	40,297	61,124

Title History <small>CARFAX guarantees the information in this section</small>	Owner 1	Owner 2	Owner 3
Salvage   Junk   Rebuilt   Fire   Flood   Hail	Guaranteed	Guaranteed	Guaranteed

Lemon

No Problem

No Problem

No Problem

Not Actual Mileage | Exceeds Mechanical Limits



**Guaranteed**  
No Problem



**Guaranteed**  
No Problem



**Guaranteed**  
No Problem



**GUARANTEED** - None of these major title problems were reported by a state Department of Motor Vehicles (DMV). If you find that any of these title problems were reported by a DMV and not included in this report, CARFAX will buy this vehicle back.

[Register](#) | [View Terms](#)



**Additional History**

Not all accidents / issues are reported to CARFAX

Owner 1

Owner 2

Owner 3

**Total Loss**

No total loss reported to CARFAX.



No Issues Reported



No Issues Reported



No Issues Reported

**Structural Damage**

No structural damage reported to CARFAX.



No Issues Reported



No Issues Reported



No Issues Reported

**Airbag Deployment**

No airbag deployment reported to CARFAX.



No Issues Reported



No Issues Reported



No Issues Reported

**Odometer Check**

No indication of an odometer rollback.



No Issues Indicated



No Issues Indicated



No Issues Indicated

**Accident / Damage**

Accidents reported on: 07/14/2013, 02/17/2018 and 06/07/2019.

**Accident Reported**

No New Issues Reported

**Accident Reported**

**Manufacturer Recall**

At least 1 manufacturer recall requires repair.



No Recalls Reported



No Recalls Reported

**Recall Reported**



**Detailed History**

**Owner 1**

Purchased: 2011













**Low mileage!** This owner drove less than the industry average of 15,000 miles per year.















Personal Vehicle  
7,532 mi/yr

Date	Mileage	Source	Comments
09/22/2011	1	Dansville Chrysler Dodge Jeep Dansville, NY 585-335-2227 dansvillechryslerdod	Vehicle offered for sale

[jeep.com/index.htm](http://jeep.com/index.htm)

09/23/2011	2	Dansville Chrysler Dodge Jeep Dansville, NY 585-335-2227 dansvillechryslerdodgejeep.com/index.htm	 <b>Vehicle serviced</b> - Pre-delivery inspection completed
09/27/2011		Carbone Select Rome, NY 315-337-0830 carboneselect.com  4.5 ★★★★★ 60 Verified Reviews 	<b>Vehicle offered for sale</b>
09/28/2011	184	Carbone Dodge Chrysler Yorkville, NY 315-736-3371 carbonedodgecity.com  4.7 ★★★★★ 20 Verified Reviews 	<b>Vehicle sold</b>
10/04/2011		Carbone Select Rome, NY 315-337-0830 carboneselect.com  4.5 ★★★★★ 60 Verified Reviews 	 <b>Vehicle serviced</b> - Mud flaps/splash guards installed - Exterior trim checked - Fuel filler door adjusted - Interior trim checked
10/06/2011		Carbone Dodge Chrysler Yorkville, NY 315-736-3371 carbonedodgecity.com  4.7 ★★★★★ 20 Verified Reviews 	 <b>Vehicle serviced</b> - Interior trim checked - Exterior trim checked - Fuel filler door adjusted
11/07/2011	185	Carbone Select Rome, NY 315-337-0830 carboneselect.com  4.5 ★★★★★ 60 Verified Reviews 	 <b>Vehicle serviced</b> - Safety inspection performed - Undercoating/rustproofing applied
11/08/2011		Carbone Dodge Chrysler Yorkville, NY 315-736-3371 carbonedodgecity.com  4.7 ★★★★★	 <b>Vehicle serviced</b> - Safety inspection performed

20 Verified Reviews 

11/08/2011	New York Inspection Station	Passed safety inspection - Emissions inspection performed  <a href="#">View what was inspected</a>
11/08/2011	New York Motor Vehicle Dept. Rome, NY	Registration issued or renewed - Titled or registered as personal vehicle - Passed safety inspection
11/09/2011	Carbone Select Rome, NY 315-337-0830 carboneselect.com  4.5  60 Verified Reviews 	Vehicle sold
12/28/2011	New York Motor Vehicle Dept. Sylvan Beach, NY	Title issued or updated - First owner reported - Loan or lien reported
01/09/2012 2,514	Carbone Select Rome, NY 315-337-0830 carboneselect.com  4.5  60 Verified Reviews 	 Vehicle serviced - Engine/powertrain computer/module checked
01/12/2012	Carbone Dodge Chrysler Yorkville, NY 315-736-3371 carbonedodgecity.com  4.7  20 Verified Reviews 	 Vehicle serviced - Engine/powertrain computer/module checked
01/21/2012 2,909	Carbone Select Rome, NY 315-337-0830 carboneselect.com  4.5  60 Verified Reviews 	 Vehicle serviced - Recommended maintenance performed
10/26/2012 11,555	Carbone Select Rome, NY 315-337-0830 carboneselect.com  4.5  60 Verified Reviews 	 Vehicle serviced - Body water leak checked

10/29/2012

Carbone Dodge Chrysler  
Yorkville, NY  
315-736-3371  
carbonedodgecity.com



**Vehicle serviced**  
- Body water leak checked

4.7 ★★★★★

20 Verified Reviews ✓

11/15/2012 12,215

New York  
Inspection Station

**Passed safety inspection**  
- Emissions inspection performed

[View what was inspected](#)

04/02/2013

New York  
Motor Vehicle Dept.  
Sylvan Beach, NY

**Registration issued or renewed**  
- Correction to record  
- Titled or registered as personal vehicle  
- Passed safety inspection

07/08/2013

New York  
Motor Vehicle Dept.  
Sylvan Beach, NY

**Registration issued or renewed**  
- Titled or registered as personal vehicle  
- Passed safety inspection

07/14/2013

New York  
Damage Report



**Accident reported**  
with another motor vehicle  
- Damage to front



Damage Location

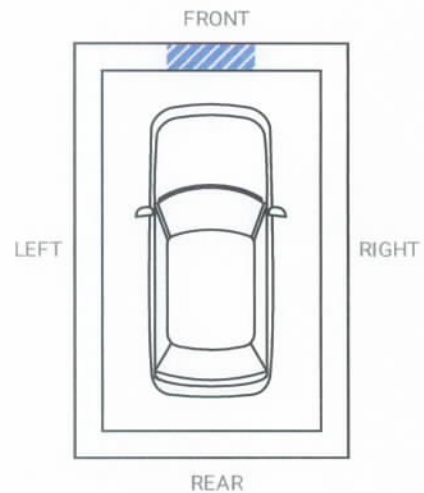

10/07/2013 17,087

Carbone Select  
Rome, NY  
315-337-0830  
carboneselect.com



**Vehicle serviced**  
- Maintenance inspection completed  
- Recommended maintenance performed  
- Fuel system checked  
- A/C and heating system checked

4.5 ★★★★★

60 Verified Reviews ✓

10/15/2013

Carbone Dodge Chrysler  
Yorkville, NY



**Vehicle serviced**  
- Maintenance inspection completed

YORKVILLE, NY  
315-736-3371  
carbonedodgecity.com

4.7 ★★★★★

20 Verified Reviews ✓

- ✓ - Maintenance inspection completed
- Recommended maintenance performed
- Fuel system checked

10/15/2013 17,395

Carbone Chrysler Dodge  
Jeep Ram  
Yorkville, NY  
315-736-3371  
carbonecdjr.com/used  
-inventory/index.htm

4.0 ★★★★★

43 Verified Reviews ✓



**Vehicle serviced**

- Maintenance inspection completed
- Fuel system checked
- A/C and heating system checked

10/22/2013

Carbone Dodge Chrysler  
Yorkville, NY  
315-736-3371  
carbonedodgecity.com

4.7 ★★★★★

20 Verified Reviews ✓



**Vehicle serviced**

- Maintenance inspection completed
- Fuel system checked
- A/C and heating system checked

12/02/2013 18,838

New York  
Inspection Station

**Passed safety inspection**

- Emissions inspection performed

[View what was inspected](#)

01/03/2015 25,584

New York  
Inspection Station

**Passed safety inspection**

- Passed emissions inspection

[View what was inspected](#)

07/06/2015

New York  
Motor Vehicle Dept.  
Sylvan Beach, NY

**Registration issued or renewed**

- Titled or registered as personal vehicle
- Passed safety inspection

10/14/2015

Romano Chrysler Jeep  
Fayetteville, NY  
315-637-3101  
romanocars.com

4.8 ★★★★★

12 Verified Reviews ✓

**Vehicle offered for sale**

10/30/2015 29,966

Romano Chrysler Jeep  
Fayetteville, NY  
315-637-3101  
romanocars.com

4.8 ★★★★★

12 Verified Reviews ✓



**Vehicle sold**

10/30/2015	Romano Chrysler Jeep Fayetteville, NY 315-637-3101 romanocars.com  4.8 ★★★★★ 12 Verified Reviews ✓	 <b>Vehicle serviced</b> - Oil and filter changed - Emissions inspection performed
10/30/2015	New York Inspection Station	<b>Passed safety inspection</b> - Passed emissions inspection  <a href="#">View what was inspected</a>
10/30/2015	New York Motor Vehicle Dept. East Syracuse, NY	<b>Registration issued or renewed</b> - Titled or registered as personal vehicle - Passed safety inspection



**Owner 2**

Personal Vehicle

Purchased: 2015

Date	Mileage	Source	Comments
11/30/2015		New York Motor Vehicle Dept. East Syracuse, NY	<b>Title issued or updated</b> - New owner reported - Loan or lien reported
02/18/2016	33,018	Romano Chrysler Jeep Fayetteville, NY 315-637-3101 romanocars.com  4.8 ★★★★★ 12 Verified Reviews ✓	 <b>Vehicle serviced</b> - Maintenance inspection completed - Oil and filter changed
07/29/2016	36,527	Midas Syracuse, NY 315-437-4391 midas.com  3.1 ★★☆☆☆ 10 Verified Reviews ✓	 <b>Vehicle serviced</b> - Oil and filter changed
10/10/2016		New York Motor Vehicle Dept. East Syracuse, NY	<b>Registration issued or renewed</b> - Titled or registered as personal vehicle - Passed safety inspection
11/07/2016	39,627	New York Inspection Station	<b>Passed safety inspection</b> - Passed emissions inspection  <a href="#">View what was inspected</a>



11/23/2016		Dealer Inventory	Vehicle offered for sale
11/27/2016	40,000	Dealer Inventory	Vehicle offered for sale
11/30/2016		Fox Toyota Subaru Auburn, NY 315-253-7341 foxtoyotasubaru.com  4.6 ★★★★★ 84 Verified Reviews ✓	 Vehicle serviced - Vehicle washed/detailed
03/29/2017	40,247	New York Inspection Station	Passed safety inspection - Failed emissions inspection  <a href="#">View what was inspected</a>
03/30/2017	40,296	Fox Toyota Subaru Auburn, NY 315-253-7341 foxtoyotasubaru.com  4.6 ★★★★★ 84 Verified Reviews ✓	 Vehicle serviced
03/30/2017		New York Inspection Station	Passed safety inspection - Passed emissions inspection  <a href="#">View what was inspected</a>
03/30/2017		New York Motor Vehicle Dept. Auburn, NY	Registration issued or renewed - Titled or registered as personal vehicle - Passed safety inspection
03/31/2017	40,297	Inspection Co.	Inspection performed

**Owner 3**

Purchased:  
2017



**Low mileage!** This owner drove less than the industry average of 15,000 miles per year.

Personal Vehicle  
9,025 mi/yr

Date	Mileage	Source	Comments
04/18/2017		New York Motor Vehicle Dept. Auburn, NY	Title issued or updated - New owner reported - Loan or lien reported
07/07/2017	41,950	Fox Chrysler Dodge Jeep Owen Sound, ON 877-885-6685	 Vehicle serviced - Battery/charging system checked

8 / 1-833-8625

- Battery charged

foxchrysler.com/index.htm

02/17/2018

New York  
Damage Report



**Accident reported**  
- Involving left front impact with another motor vehicle  
- Damage to front



Damage Location

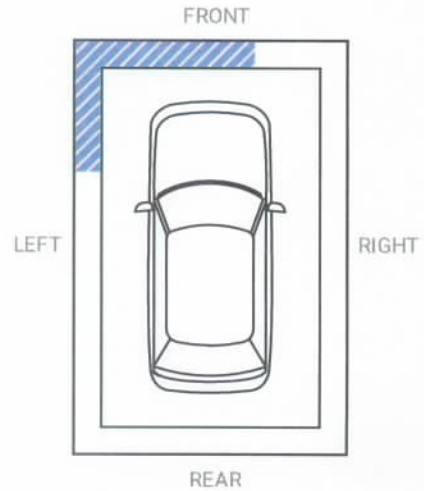

04/03/2018 48,250

New York  
Inspection Station

**Failed safety inspection**  
- Passed emissions inspection

[View what was inspected](#)

04/03/2018

Fox Chrysler Dodge Jeep  
Auburn, NY  
315-252-7273  
foxcdj.com



**Vehicle serviced**  
- Maintenance inspection completed  
- Safety inspection performed  
- Emissions inspection performed

4.5 ★★★★★

42 Verified Reviews ✓

04/05/2018 48,255

Anderson's Automotive  
.llc  
Auburn, NY  
315-282-7095  
https://facebook.com/anderson.automotive  
1/



**Vehicle serviced**

04/05/2018

New York  
Inspection Station

**Passed safety inspection**  
- Passed emissions inspection

[View what was inspected](#)

09/07/2018 53,548

Anderson's Automotive  
.llc



**Vehicle serviced**

Auburn, NY  
315-282-7095  
https://facebook.com  
/anderson.automotive  
1/

01/15/2019

FCA US LLC

**Manufacturer Safety recall issued**

- NHTSA #19V-018
- #V01 PASSENGER AIRBAG INFLATOR
- Status: Remedy available

[Click here](#) for a copy of the owner letter for this Recall or call 1- 800-853-1403 if you have any questions or need additional information on this recall.

- [Learn more about this recall](#)

Description: Some of the above vehicles may contain propellant that degraded after prolonged exposure to high absolute humidity, high temperatures and high temperature cycling. Activation of an inflator with degraded propellant, in a vehicle crash where the PAB is designed to deploy, may result in an inflator explosion.

An inflator explosion may cause metal fragments to pass through the air bag and into the vehicle interior at high speed, which may result in injury or death to vehicle occupants.

Remedy: Replace the PAB inflator

03/05/2019

New York  
Motor Vehicle Dept.  
Auburn, NY

**Registration issued or renewed**

- Titled or registered as personal vehicle
- Passed safety inspection

05/09/2019 58,993

New York  
Inspection Station

**Passed safety inspection**

- Passed emissions inspection

[View what was inspected](#)

06/07/2019

New York  
Damage Report



**Accident reported**

- Involving front impact with another motor vehicle

Damage Location

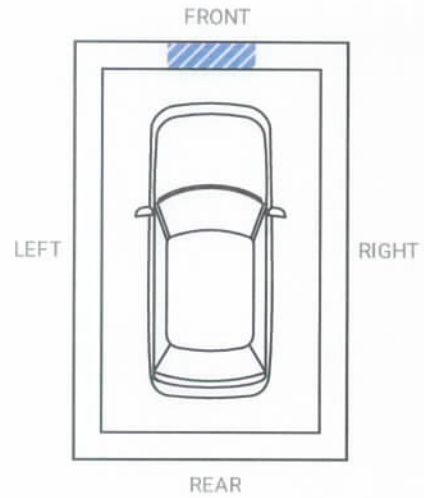

08/20/2019 61,088

Summit Chevrolet Buick  
GMC, Inc.  
Auburn, NY  
315-258-2000  
summitcars.com

Vehicle offered for sale

3.7 ★★★★★  
24 Verified Reviews ✓

08/21/2019 61,090

Summit Chevrolet Buick  
GMC, Inc.  
Auburn, NY  
315-258-2000  
summitcars.com



Vehicle serviced

- Pre-delivery inspection completed
- Maintenance inspection completed
- Oil and filter changed
- Tire condition and pressure checked

3.7 ★★★★★  
24 Verified Reviews ✓

09/16/2019 61,124

Auto Auction  
New York

Listed as a dealer vehicle

- Vehicle sold



Millions of used vehicles are bought and sold at auction every year.

09/19/2019

Summit Chevrolet Buick  
GMC, Inc.  
Auburn, NY  
315-258-2000  
summitcars.com

Vehicle sold

3.7 ★★★★★  
24 Verified Reviews ✓

Have Questions? Consumers, please visit our Help Center at [www.carfax.com](http://www.carfax.com). Dealers or Subscribers, please visit our Help Center at [www.carfaxonline.com](http://www.carfaxonline.com).



## Glossary

### Accident Indicator

CARFAX receives information about accidents in all 50 states, the District of Columbia and Canada.

Not every accident is reported to CARFAX. As details about the accident become available, those additional details are added to the CARFAX Vehicle History Report. CARFAX recommends that you have this vehicle inspected by a qualified mechanic.

- According to the National Safety Council, Injury Facts, 2015 edition, 8% of the 254 million registered vehicles in the U.S. were involved in an accident in 2013. Over 74% of these were considered minor or moderate.
- This CARFAX Vehicle History Report is based only on information supplied to CARFAX and available as of 10/4/19 at 3:27:27 PM (CDT). Other information about this vehicle, including problems, may not have been reported to CARFAX. Use this report as one important tool, along with a vehicle inspection and test drive, to make a better decision about your next used car.

### New York Damage Reports:

- Do not include an assessment of damage severity
- Are required if the estimated damage exceeds \$1000

### Failed Emissions Inspection

The emissions check performed during a vehicle inspection indicated the vehicle was emitting more than allowable emissions standards and/or had missing or modified parts. Repeated failed emissions records can indicate engine problems and CARFAX recommends you have the vehicle inspected.

### First Owner

When the first owner(s) obtains a title from a Department of Motor Vehicles as proof of ownership.

### Manufacturer Recall

Automobile manufacturers issue recall notices to inform owners of car defects that have come to the manufacturer's attention. Recalls also suggest improvements that can be made to improve the safety of a particular vehicle. Most manufacturer recalls can be repaired at no cost to you.

### New Owner Reported

When a vehicle is sold to a new owner, the Title must be transferred to the new owner(s) at a Department of Motor Vehicles.

### Ownership History

CARFAX defines an owner as an individual or business that possesses and uses a vehicle. Not all title transactions represent changes in ownership. To provide estimated number of owners, CARFAX proprietary technology analyzes all the events in a vehicle history. Estimated ownership is available for vehicles manufactured after 1991 and titled solely in the US including Puerto Rico. Dealers sometimes opt to take ownership of a vehicle and are required to in the following states: Maine, Massachusetts, New Jersey, Ohio, Oklahoma, Pennsylvania and South Dakota. Please consider this as you review a vehicle's estimated ownership history.

### Title Issued

A state issues a title to provide a vehicle owner with proof of ownership. Each title has a unique number. Each title or registration record on a CARFAX report does not necessarily indicate a change in ownership. In Canada, a registration and bill of sale are used as proof of ownership.

Canada, a registration and bill of sale are used as proof of ownership.

Follow Us:



[facebook.com/CARFAX](https://facebook.com/CARFAX)



[@CarfaxReports](https://twitter.com/CarfaxReports)



About CARFAX

CARFAX DEPENDS ON ITS SOURCES FOR THE ACCURACY AND RELIABILITY OF ITS INFORMATION. THEREFORE, NO RESPONSIBILITY IS ASSUMED BY CARFAX OR ITS AGENTS FOR ERRORS OR OMISSIONS IN THIS REPORT. CARFAX FURTHER EXPRESSLY DISCLAIMS ALL WARRANTIES, EXPRESS OR IMPLIED, INCLUDING ANY IMPLIED WARRANTIES OF MERCHANTABILITY OR FITNESS FOR A PARTICULAR PURPOSE. CARFAX®

© 2019 CARFAX, Inc., a unit of IHS Markit. All rights reserved.

Covered by United States Patent Nos. 7,113,853; 7,778,841; 7,596,512, 8,600,823; 8,595,079; 8,606,648; 7,505,838.

10/4/19 3:27:27 PM (CDT)

I have reviewed and received a copy of the CARFAX Vehicle History Report for this 2012 JEEP WRANGLER vehicle (VIN: 1C4AJWAGXCL126496), which is based on information supplied to CARFAX and available as of 10/4/19 at 4:27 PM (EDT).

Customer Signature

Date

Dealer Signature

Date

# Auto **LINK** *Connecting Customers With Quality!*

## 2012 JEEP WRANGLER SPORT 2DR 3.6/A5 4X4

### Standard Equipment For This Vehicle Type When Newly Manufactured:

#### — INTERIOR FEATURES —

12-Volt Auxiliary Power Outlet  
6-Speaker Audio System  
Air Conditioning  
AM/FM Stereo CD/MP3/WMA Player  
Auxiliary Audio Jack  
Auxiliary Power Outlets  
Center Armrest  
Cloth Seating Fabric  
Compass Display  
Cruise Control  
Fold-Down Windshield Sunscreen  
Tilt Steering Column

#### — EXTERIOR FEATURES —

Fog Lamps  
Halogen Headlamps  
Manual Exterior Mirrors  
Removable Front Air Dam  
Removable Full-Frame Doors w/Roll-Up Windows  
Soft Folding Top Roof  
Sunrider Soft Top System  
Variable Intermittent Front Windshield Wipers

#### — ENGINEERING FEATURES —

Brake-Lock Differentials  
Command-Trac 4-Wheel Drive System  
Electronic Brake Distribution & Brake Assist  
Electronic Roll Mitigation  
Electronic Stability Control & Traction Control  
Power 4-Wheel Disc Anti-Lock Brakes  
Power Recirculating Ball Steering  
Power Recirculating Ball Steering System  
Shift-On-The-Fly 4WD Capability  
Tachometer

Tire Pressure Monitoring System

#### — SAFETY FEATURES —

Driver & Front Passenger Frontal Airbags  
LATCH Child Safety Seat Anchors  
Sentry Key Engine Immobilizer

Engine: 3.6L DOHC 24V V6  
Trans: 5-Speed Automatic  
VIN Number: 1C4AJWAGXCL126496  
Stock No.: D126496  
Odometer: 61,264  
Ext. Color: DOZER ORANGE  
Int. Color: BLACK  
Wheelbase: 95.4  
Length: 168.3  
Height: 72.4  
Width: 73.7  
Seating Capacity: 4  
Fuel Capacity: 18.6

The Wrangler Rubicon was awarded Best-In-Class Hard-Core 4X4 by Truck Trend \* AutoWeek calls the Wrangler a vehicle with true power \* AutoWeek calls the Wrangler's cabin reasonably quiet and it's body well-composed during conventional maneuvers \* Motor Trend notes the Wrangler's engine has excellent response (Sport) \* Motor Trend calls the Wrangler a true American classic \* U.S. News reports the Wrangler to be loved for its rugged off-road capabilities and boxy styling \*

AUTO LINK, INC.  
101 East Colonial Highway  
Hamilton, VA 20158  
540-338-5465

NADA Book Value \$18,950.00

Our Price \$18,425.00

CITY MPG **17** FUEL ECONOMY INFORMATION HWY MPG **21**



[www.autolinkonline.net](http://www.autolinkonline.net)

Mon-Thurs 9-5 | Sat 9-5

Friday & Sunday by Appointment

**Call Today! 540-338-LINK (5465)**

IT IS THE RESPONSIBILITY OF THE BUYER TO ADDRESS ANY AND ALL DIFFERENCES BETWEEN INFORMATION ON THIS LABEL AND THE ACTUAL VEHICLE AND/OR ANY WARRANTIES OFFERED PRIOR TO THE SALE OF THIS VEHICLE. Data on this label is compiled from publicly available sources believed by the publisher to be reliable. The publisher assumes no responsibility for errors and/or omissions in the compilation of this data, and makes no representations, expressed or implied, to any actual or prospective purchaser of this vehicle as to the condition of the vehicle, ownership, vehicle history, listed equipment/accessories, price or warranties. Fuel economy estimates are for newly manufactured vehicles. Actual fuel economy may vary with driving conditions, vehicle condition/age. See dealer for details. Copyright 2005 TWD. www.windowstickers.biz Printed in U.S.A.

CALL 1-262-240-9707 **VEHICLE Details** TO RE-ORDER THIS FORM

## 2012 JEEP WRANGLER SPORT 2DR 3.6/A5 4X4

**Engine:** 3.6L DOHC 24V V6  
**Trans:** 5-Speed Automatic  
**VIN No.:** 1C4AJWAGXCL126496  
**Stock No.:** D126496  
**Odometer:** 61264  
**Interior Color:** BLACK  
**Exterior Color:** DOZER ORANGE  
**Wheelbase:** 95.4  
**Length:** 168.3  
**Width:** 73.7  
**Height:** 72.4  
**Seats:** 4  
**Fuel Capacity:** 18.6

The Wrangler Rubicon was awarded Best-In-Class Hard-Core 4X4 by Truck Trend \* AutoWeek calls the Wrangler a vehicle with true power \* AutoWeek calls the Wrangler's cabin reasonably quiet and it's body well-composed during conventional maneuvers \* Motor Trend notes the Wrangler's engine has excellent response (Sport) \* Motor Trend calls the Wrangler a true American classic \* U.S. News reports the Wrangler to be loved for its rugged off-road capabilities and boxy styling \*

### Standard Equipment For This Vehicle Type When Newly Manufactured:

- INTERIOR FEATURES —
- 12-Volt Auxiliary Power Outlet
  - 6-Speaker Audio System
  - Air Conditioning
  - AM/FM Stereo CD/MP3/WMA Player
  - Auxiliary Audio Jack
  - Auxiliary Power Outlets
  - Center Armrest
  - Cloth Seating Fabric
  - Compass Display
  - Cruise Control
  - Fold-Down Windshield Sunscreen
  - Tilt Steering Column
- EXTERIOR FEATURES —
- Fog Lamps
  - Halogen Headlamps
  - Manual Exterior Mirrors
  - Removable Front Air Dam
  - Removable Full-Frame Doors w/Roll-Up Windows
  - Soft Folding Top Roof
  - Sunrider Soft Top System
  - Variable Intermittent Front Windshield Wipers
- ENGINEERING FEATURES —
- Brake-Lock Differentials
  - Command-Trac 4-Wheel Drive System
  - Electronic Brake Distribution & Brake Assist
  - Electronic Roll Mitigation
  - Electronic Stability Control & Traction Control
  - Power 4-Wheel Disc Anti-Lock Brakes
  - Power Recirculating Ball Steering
  - Power Recirculating Ball Steering System
  - Shift-On-The-Fly 4WD Capability
  - Tachometer
  - Tire Pressure Monitoring System
- SAFETY FEATURES —
- Driver & Front Passenger Frontal Airbags
  - LATCH Child Safety Seat Anchors
  - Sentry Key Engine Immobilizer
  - Sentry Key Engine Immobilizer System
  - Sport Bar Rollover Protection

Vehicle Facts: Jeep Wrangler returns for 2012 with an all-new 3.6-liter V6 powertrain that provides more fuel efficiency, improved on-road driving dynamics, more power and more torque \* The new Wrangler powertrain now offers a 5-speed automatic transmission \* For 2012, Wrangler Rubicon models share a body-colored hard top with Sahara models \* Jeep Wrangler is offered in a 2-door body style as the Wrangler, and a 4-door body style as the Wrangler Unlimited \* Jeep Wrangler is available in Sport, Sport S, Sahara and Rubicon trim variants \* Combined with an all-new interior released in 2011, the Jeep Wrangler is virtually all new over the past two years \* Jeep Wrangler features a best-in-class approach angle of 46.6 degrees, breakover angle of 25.5 degrees and best-in-class departure angle of 40.6 degrees \* Sport and Sahara models include a Dana 30 front axle and Dana 44 rear axle \* The Command-Trac NV241 part-time 2-speed transfer case features a 2.72:1 low-range gear ratio; the optional Trac-Lok limited-slip rear differential provides extra torque and grip in low-traction environments \* Wrangler Rubicon models feature heavy-duty Dana 44 front and rear axles and the Rock-Trac NV241 2-speed transfer case with a 4.0:1 low-range gear ratio \* Jeep Wrangler is powered by a 3.6-liter DOHC 60-degree liquid cooled V6 engine rated at 285 HP at 6400 RPM with a torque rating of 260 lbs.-ft. at 4800 RPM, coupled with a choice of 6-speed manual overdrive transmission or 5-speed automatic overdrive transmission \*\*

REASONS TO BUY: Available steering wheel controls give the driver access to audio and cruise controls without the need to remove hands from the wheel \* Jeep engineers significantly increased the acoustical treatment of the Wrangler, reducing interior noise, vibration and harshness \* An available electronic-disconnecting front stabilizer bar – the active sway bar system - delivers additional wheel travel for challenging terrain \* Underbody protection is provided by three skid plates – protecting the fuel tank, transfer case and automatic transmission oil pan \* The anti-lock brake system employs tuning for 4-wheel drive and off-road operation, offering additional control on unimproved surfaces \* Trail Rated Jeep models feature additional electrical and body sealing, along with a high air intake, for optimum water fording capability \* Wrangler Rubicon models offer a best-in-class 10 inches of ground clearance, helped in part by the standard tires \* A two-piece oil pan provides a steel lower portion for impact resistance with an upper aluminum section for weight savings \* The fully boxed frame adds strength and torsional rigidity, for added durability \* Extra-tough body-mounted rails provide additional protection on Rubicon models \* Warning chime for headlights-on, key-in-ignition, seat belt use, and high coolant temperature adds security and peace of mind \*

NADA Book Value \$18,950.00

**Our Price \$18,425.00**

**AUTO LINK, INC.**  
**101 East Colonial Highway**  
**Hamilton, VA 20158**  
**540-338-5465**

<b>CITY MPG</b>	<b>FUEL ECONOMY INFORMATION</b>	<b>HWY MPG</b>
17		21

ANY AND ALL DIFFERENCES BETWEEN THE INFORMATION PRESENTED ON THIS DOCUMENT AND THE ACTUAL VEHICLE ITSELF AND/OR ANY WARRANTIES OFFERED MUST BE ADDRESSED PRIOR TO THE SALE OF THIS VEHICLE. Data, specifications, and equipment information shown are compiled from publicly available sources believed by the publisher to be reliable. Data is subject to change without notice. The publisher assumes no responsibility for errors or omissions in the compilation of this data. Vehicle Information Sheets are prepared by the dealer solely for the dealership's use and convenience. The publisher makes no representations, express or implied, to any actual or prospective buyer of the vehicle as to the existence, description or condition of the vehicle, listed equipment, price or warranties. Fuel economy estimates are for newly manufactured vehicles. Fuel economy may vary depending on driving conditions and vehicle age/condition. See dealer for details. Copyright 2007 TWD.



# BUYERS GUIDE

**IMPORTANT:** Spoken promises are difficult to enforce. Ask the dealer to put all promises in writing. Keep this form.  
JEEP WRANGLER SPORT 2DR 3.6/A5 4X012 1C4AJWAGXCL126496

VEHICLE MAKE MODEL YEAR VEHICLE IDENTIFICATION NUMBER (VIN)

## WARRANTIES FOR THIS VEHICLE:

### AS IS - NO DEALER WARRANTY

THE DEALER DOES NOT PROVIDE A WARRANTY FOR ANY REPAIRS AFTER SALE.

### DEALER WARRANTY

FULL WARRANTY.

LIMITED WARRANTY. The dealer will pay 100% of the labor and 100% of the parts for the covered systems that fail during the warranty period. Ask the dealer for a copy of the warranty, and for any documents that explain warranty coverage, exclusions, and the dealer's repair obligations. *Implied warranties* under your state's laws may give you additional rights.

#### SYSTEMS COVERED:

Engine Unit  
Transmission Unit  
Steering Unit  
Brake Pads and Shoes

#### DURATION:

90 Days or 3000 Miles. Whichever comes first.  
90 Days or 3000 Miles. Whichever comes first.  
90 Days or 3000 Miles. Whichever comes first.  
90 Days or 3000 Miles. Whichever comes first.

## NON-DEALER WARRANTIES FOR THIS VEHICLE:

- MANUFACTURER'S WARRANTY STILL APPLIES. The manufacturer's original warranty has not expired on some components of the vehicle.
- MANUFACTURER'S USED VEHICLE WARRANTY APPLIES.
- OTHER USED VEHICLE WARRANTY APPLIES.

Ask the dealer for a copy of the warranty document and an explanation of warranty coverage, exclusions, and repair obligations.

- SERVICE CONTRACT. A service contract on this vehicle is available for an extra charge. Ask for details about coverage, deductible, price, and exclusions. If you buy a service contract within 90 days of your purchase of this vehicle, *implied warranties* under your state's laws may give you additional rights.

**ASK THE DEALER IF YOUR MECHANIC CAN INSPECT THE VEHICLE ON OR OFF THE LOT.**

**OBTAIN A VEHICLE HISTORY REPORT AND CHECK FOR OPEN SAFETY RECALLS.** For information on how to obtain a vehicle history report, visit [ftc.gov/usedcars](http://ftc.gov/usedcars). To check for open safety recalls, visit [safercar.gov](http://safercar.gov). You will need the vehicle identification number (VIN) shown above to make the best use of the resources on these sites.

**SEE OTHER SIDE for important additional information, including a list of major defects that may occur in used motor vehicles.**

Si el concesionario gestiona la venta en español, pídale una copia de la Guía del Comprador en español.

CAUTION: DO NOT PLACE STICKER ON TINTED GLASS | PLACE STICKER ON CLEAN GLASS | APPLY BETWEEN 0° & 100° F | SPLIT SEAM TO REMOVE BORDER & EXPOSE ADHESIVE

# INSPECTION CERTIFICATION VIRGINIA STATE POLICE

Inspection Date: 10/04/2019

Sticker Number: A6414305

Month Insert: 11564041

Station: 4071 - AUTO LINK, INC.

Inspector: 1446 - LYLES, JOEL W

License No:

Make: JEEP

Body Type: SUV

VIN: 1C4AJWAGXCL126496

Year Built: 2012

Odometer Reading: 61264

Inspection Fee: \$ 20.00

Related Charges: \$ 0.00

Total Charges: \$ 20.00

Wheels Inspected:	RF	X	LF	X	RR	X	LR	X
-------------------	----	---	----	---	----	---	----	---

EQUIPMENT INSPECTED	O.K.	ADJUST	INSTALL	REMOVE
BRAKES	X			
HEADLIGHTS	X			
SIGNAL LIGHTS	X			
OTHER LIGHTS	X			
STEERING	X			
SUSPENSION	X			
EXHAUST SYSTEM	X			
FUEL SYSTEM	X			
TIRES	X			
HOOD LATCH	X			
EMISSION CONTROL	X			
WINDSHIELD	X			
WINDSHIELD WIPERS	X			
OTHER GLASS	X			
MIRROR	X			
DOORS	X			
SEATS	X			
SEAT BELTS	X			
FLOOR PAN	X			
DEFROSTER	X			
HORN	X			

Printed: 10/05/2019 02:45 PM ID: 98196803



**COMMONWEALTH OF VIRGINIA  
VEHICLE EMISSIONS INSPECTION REPORT**



Test Date/Time: 10/09/2019 @ 13:15:29  
Inspection Type: Initial

**OVERALL TEST RESULTS: PASS**

		VEHICLE INFORMATION						
Year:	2012	Make:	JEEP	Model:	WRANGLER	Cylinders:	6	
VIN:	1C4AJWAGXCL126496	Engine Size:	3.6 L	Mileage:	61,265			
GVWR:	4900	ETW:	N/A					
TSI TAILPIPE EMISSIONS INSPECTION				EMISSIONS CONTROL SYSTEM INSPECTION				
		2500 RPM		Idle				
	Limit	Reading	Result	Limit	Reading	Result		
HC ppm	N/A	N/A	N/A	N/A	N/A	N/A	Air Injection System: N/A	
CO %	N/A	N/A	N/A	N/A	N/A	N/A	Exhaust Gas Recirculation System: N/A	
NO ppm	N/A	N/A	N/A	N/A	N/A	N/A	Positive Crankcase Ventilation System: N/A	
	RPM	N/A	N/A	RPM	N/A	N/A	Catalytic Converter: PASS	
	Dilution %	N/A	N/A	Dilution %	N/A	N/A	Fuel Evaporative System: N/A	
VISIBLE SMOKE INSPECTION: PASS				ON BOARD DIAGNOSTIC SYSTEM INSPECTION				
				OBD Malfunction Indicator Lamp: PASS				
				OBD Diagnostic Trouble Codes: PASS				

**PLEASE RETAIN THIS DOCUMENT FOR YOUR RECORDS**

Results of the emissions inspection for this vehicle will be transmitted electronically to DMV, usually within 24 hours.  
You may now register this vehicle for a period of up to two (2) years.

EMISSIONS INSPECTION STATION			
STATION NAME:	Progressive Automotive	REPORT NUMBER:	3030
ADDRESS:	11 E Colonial Highway	STATION NUMBER:	1328
PHONE:	5403381857	ANALYZER NUMBER:	VA424511
INSPECTOR NAME:	Welty, Mark W.	SOFTWARE VERSION:	19.03.02

<p align="center"><b>VEHICLE EMISSIONS INSPECTION QUESTIONS</b></p> <p>For additional information, please contact the Department of Environmental Quality Air Check Virginia (703) 583-3900 or (800) 275-3844 <a href="http://www.deq.virginia.gov/Programs/AirCheckVirginia.aspx">www.deq.virginia.gov/Programs/AirCheckVirginia.aspx</a></p>	 Inspector's Signature
--	---

	<b>Transaction ID Number: F0DCE261</b>	<b>Version: 3.02</b>
--	--	----------------------

AUTO LINK INC.

101 EAST COLONIAL HWY.  
 PO. BOX 98  
 HAMILTON, VA 20158

# Invoice

Date	Invoice #
10/19/2019	489

Bill To
AUTO LINK INC.-69 PLY 101 EAST COLONIAL HWY. HAMILTION, VA. 20158

Ship To

P.O. Number	Terms	Rep	Ship	Via	F.O.B.	Project
			10/19/2019			

Quantity	Item Code	Description	Price Each	Amount
		2012 JEEP WRANGLER SPORT - 1C4AJWAGXCL126496 SERVICE @ 61264:		
6	PARTS	MOBIL 1 5W-30 SYNTHETIC OIL WS760WW	9.50	57.00T
1	PARTS	PREM OIL FILTER WS279SW	10.99	10.99T
1	PARTS	MISC. 1439ATNWS	22.81	22.81T
1	PARTS	BRAKE FLUID	15.00	15.00T
1	PARTS	SHOP SUPPL/RECYCLE FEE	20.00	20.00T
4	PARTS	MISC. & DETAIL SUPPL WS739HH	14.69	58.76T
5	PARTS	TPMS SENSOR 3WS3546GH	62.60	313.00T
1	LABOR	DETAIL & DEALER PREP / OVERALL CHECK OUT	250.00	250.00
1	LABOR	OIL CHANGE	35.00	35.00
1	LABOR	STATE INSPECTION	20.00	20.00
1	LABOR	EMISSIONS INSPECTION	28.00	28.00
1	LABOR	R&R 5 TPMS SENSORS & BALANCE TIRES	235.00	235.00
1	LABOR	REPAIR CATALYTIC CONVERTER SHIELD	27.00	27.00
1	LABOR	FLUSH BRAKE SYSTEM	92.00	92.00
1	LABOR	CHECK BRAKE SYSTEM & CLEAN E-BRAKE HUB	92.00	92.00
		Sales Tax	6.00%	29.85

ALL WORK HAS BEEN COMPLETED.TECH COMMENTS:VEHICLE PERFORMS EXCELLENT.	<b>Total</b>	\$1,306.41
---	--------------	------------

# Angie's list

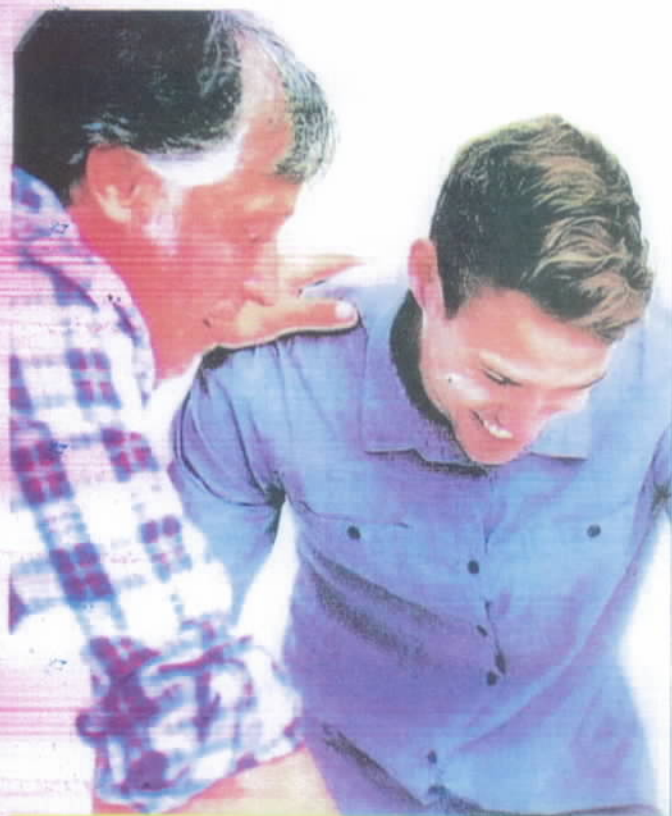

## You've been **REVIEWED!**

Your customer posted a review on their experience with you

# Read what they said

Angie's list. 1030 E. Washington St. Indianapolis, IN 46202

Angie's List connects serious consumers searching for quality service providers. Members pay or access to providers offering the best service based on the feedback of other members.

PRSR STD  
U.S. Postage  
PAID  
Plum Grove

2160 Stonington Ave.  
Hoffman Estates, IL 60116

"I have used them for about 35 years and I think they are excellent! Their prices are reasonable, and they do excellent work! They are very pleasant people. They are professional and on time."

- Example Member Review

Read your review and learn how your FREE account can help you grow your business. Visit [Business.AngiesList.com](http://Business.AngiesList.com), or call 1-866-843-LIST (5478).

## You've Been Reviewed!

Your customer has posted a review about you

**Auto LINK**

101 E. Colonial Hwy.  
Hamilton, VA 20158  
Phone: 540-338-LINK (5465)  
Fax: 540-338-7318  
<http://www.autolinkonline.net>

Connecting Customers with Quality!

JOEL LYLES